

OPERATING MANUAL

DIGITAL POWER CLAMP METER

850FN

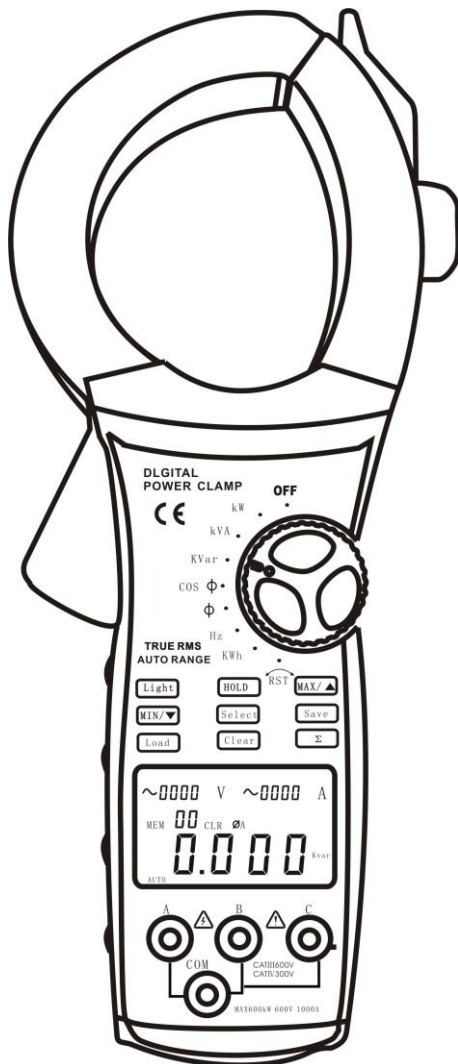

TABLE OF CONTENTS

TITLE	PAGE
Overview.....	1
Unpacking Inspection.....	1
Safety Information.....	2
Rules For Safe Operation.....	2
International Electrical Symbols.....	4
A. The Meter Structure.....	4
B. The Meter Front Structure.....	4
Functional Buttons.....	6
Display Symbols.....	8
Measurement Operation.....	10
A. AC Voltage + Frequency Measurement.....	10
B. AC Current + AC Voltage Measurement.....	11
C. Active Power + Phase Angle Measurement.....	12
D. Apparent Power + Reactive Power Measurement.....	19
E. Power Factor + Phase Angle Measurement.....	21
F. Active Energy + Time Measurement.....	23
G. Phase Angle + Voltage + Current.....	24
H. Frequency + Voltage + Current.....	25
I. Active Energy + Active Power + Time.....	27
J. Phase Sequence Detection.....	28
True RMS Measurement and Average Value Measurement.....	27
Specifications.....	30
A. General Specifications.....	30
B. Environmental Requirements.....	31
Accuracy Specifications.....	32
A. AC Voltage.....	32
B. Frequency.....	32
C. AC Current.....	32
D. Active Power.....	33
E. Apparent Power.....	33
F. Reactive Power.....	34
G. Power Factor.....	34
H. Phase Angle.....	35
I. Active Energy.....	35
Maintenance.....	35
A. General Service.....	35
B. Replacing the Battery.....	36

Overview

This Operating Manual covers information on safety and cautions. Please read the relevant information carefully and observe all the **Warnings** and **Notes** strictly.

Warning

To avoid electric shock or personal injury, read the “Safety Information” and “Rules for Safe Operation” carefully before using the Meter.

This is a three phase intelligent handheld digital power clamp meter (hereafter referred to as “the Meter”) which has both the features of digital current meter and also power measurement meter.

The Meter can measure Voltage, Current, Active Power, Apparent Power, Reactive Power, Power Factor, Phase Angle, Frequency, Active Energy and etc.

Unpacking Inspection

Open the package case and take out the Meter. Check the following items carefully to see any missing or damaged part:

Item	Description	Qty
1	English Operating Manual	1 piece
2	Red Test Lead	1 piece
3	Black Test Lead	1 piece
4	Blue Test Lead	1 piece
5	Yellow Test Lead	1 piece
6	Red Alligator Clip	1 piece
7	Black Alligator Clip	1 piece
8	Blue Alligator Clip	1 piece
9	Yellow Alligator Clip	1 piece
10	Tool Box	1 piece
11	<u>9 V Alkaline batteries</u>	1 pieces

In the event you find any missing or damage, please contact your dealer immediately.

Safety Information

This Meter complies with the standards IEC61010: in pollution degree 2, overvoltage category (CAT. III 600V,CAT IV 300V) and double insulation.

CAT. III: Distribution level, fixed installation, with smaller transient overvoltages than CAT. IV

CAT.IV: Primary supply level, overhead lines, cable systems etc.

Use the Meter only as specified in this operating manual, otherwise the protection provided by the Meter may be impaired.

In this manual, a **Warning** identifies conditions and actions that pose hazards to the user, or may damage the Meter or the equipment under test.

A **Note** identifies the information that user should pay attention to

International electrical symbols used on the Meter and in this Operating Manual are explained on page 6.

Rules For Safe Operation

Warning







To avoid possible electric shock or personal injury, and to avoid possible damage to the Meter or to the equipment under test, adhere to the following rules:

- **Before using the Meter inspect the case. Do not use the Meter if it is damaged or the case (or part of the case) is removed. Look for cracks or missing plastic. Pay attention to the insulation around the connectors.**
- **Inspect the test leads for damaged insulation or exposed metal. Replace damaged test leads with identical model number or electrical specifications before using the Meter.**
- **Do not apply more than the rated voltage, as marked on the Meter.**
- **When measurement has been completed, disconnect the connection between the test leads and the circuit under test, remove the testing leads away from the input terminals of the Meter and turn the Meter power off.**
- **Do not carry out the measurement when the Meter's back case and**

/ or battery door is opened to avoid electric shock.

- **When the Meter working at an effective voltage over 30V in AC, special care should be taken.**
 - **Use the proper terminals and function for your Measurements.**
 - **Do not use or store the Meter in an environment of high temperature, humidity, explosive, inflammable and strong magnetic field. The performance of the Meter may deteriorate after dampened.**
 - **Do not use the Meter if the surface of it is wet or the user's hands are wet.**
 - **When using the test leads, keep your fingers behind the finger guards.**
 - **Replace the battery as soon as the battery Indicator  appears. With a low battery, the Meter might produce false readings that can lead to electric shock and personal injury.**
 - **When opening the battery door, must make sure the Meter is power off.**
 - **When servicing the Meter, use only the same model number or identical electrical specifications replacement parts.**
 - **The internal circuit of the Meter shall not be altered at will to avoid damage of the Meter and any accident.**
 - **Soft cloth and mild detergent should be used to clean the surface of the Meter when servicing.**
- No abrasive and solvent should be used to prevent the surface of the Meter from corrosion, damage and accident.**
- **The Meter is suitable for indoor use.**
 - **Turn the Meter off when it is not in use and take out the battery when not using for a long time.**
 - **Constantly check the battery as it may leak when it has been using for some time, replace the battery as soon as leaking appears.**
- A leaking battery will damage the Meter.**

International Electrical Symbols

	AC (Alternating Current)
	Grounding
	Double Insulated
	Warning. Refer to the Operating Manual
	Deficiency of Built-In Battery
	Danger of High Voltage
	Conforms to Standards of European Union

The Meter Structure

A. The Meter Front Structure (see figure 1)

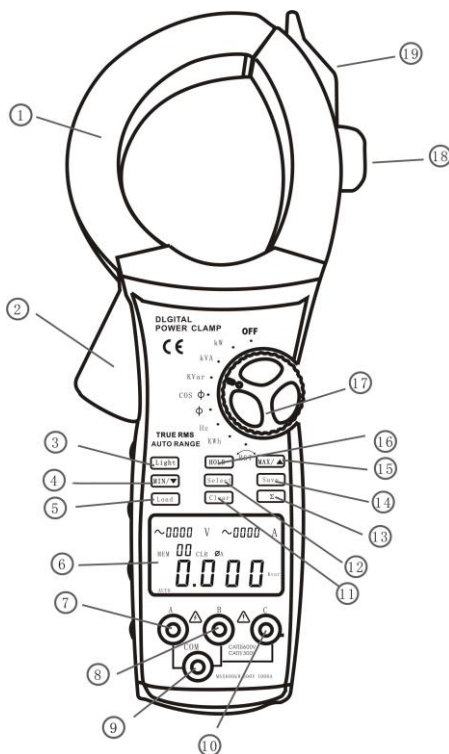



figure 1

1	Transformer Jaw: designed to pick up the AC and DC current flowing through the conductor. It could transfer current to voltage. The tested conductor must vertically go through the Jaw center
2	Hand Guards: to protect user's hand from touching the dangerous area.
3	LIGHT button (auto display backlight button)
4	MIN/ ▼ button
5	LOAD button (recall data)
6	LCD Display
7	A Input Terminal (First phase measurement)
8	B Input Terminal (Second phase measurement)
9	COM Input Terminal
10	C Input Terminal (Third phase measurement)
11	CLEAR button (maximum and minimum)
12	SELECT button (press to select alternate function and sum of Watts measurement)
13	□ button (Sum)
14	SAVE button (data store button)
15	Max/▲ button
16	HOLD button
17	Rotary Switch
18	The distributing line device will avoid the dangerous when distributing electrical wire with hands
19	Leads Cramp in the Clamp easy for fixed one Lead when you need test two separation vertices

B. Button operation performed

Button	Operation Performed
HOLD	<ul style="list-style-type: none"> ● Press HOLD to enter the Hold mode in any mode,  appears and the Meter beeps. ● Press HOLD again to exit the Hold mode to return to measurement mode, the Meter beeps and  disappears.
LIGHT	<ul style="list-style-type: none"> ● Press LIGHT to turn the display backlight on. ● The display backlight will be off automatically after 30 seconds.
Rotary Switch	<p>use this switch to select functions</p> <ul style="list-style-type: none"> ● “kW” Range--Active power ● “kVA” Range--Apparent power ● “kVar” Range --Reactive Power ● “COS ϕ” Range--Power factor ● “ϕ” Range-- Phase Angle ● “Hz” Range-- Frequency ● “kWh” Range--Active Energy ● “RST” Range-- Phase sequence detection
MAX/▲	<ul style="list-style-type: none"> ● Press to start recording of maximum value, it valid at voltage, current, active power and apparent power ranges only. ● Press once at LOAD mode, MR icon shown, the Meter displays the next stored reading, the left secondary display showing the index increase one. ● Press once at Σ mode, CAL icon shown, the Meter steps through sum of active power (main display) + sum of reactive power (secondary display) and sum of power factor (main display) + sum of apparent power.
LOAD	<ul style="list-style-type: none"> ● Press once to enter LOAD mode, MR appears and the Meter beeps. ● Press again to exit LOAD mode, MR disappears and the Meter beeps. ● Press and hold LOAD for 1 second to display the stored data quickly. <p>NOTICE: Please make sure switch choose corresponding function when load data.</p> <p>For example : save data in KW function, If want load it again , should turn on rotary switch choose KW function first.</p>

Σ	<ul style="list-style-type: none"> ● At Active power (main display) + Phase angle (secondary display) mode, press Σ once button to sum up the current first phase of 3 phase measurement result. Then carry out second phase power measurement. ● Press Σ again to sum up the second phase power measurement result, then carry out third phase power measurement. ● Press Σ again to sum up the third phase power measurement result, then press SELECT to enter the measurement of sum of the watts mode, the display shows the 3 phase sum of the watts value. ● If got needless phase result when measure 2 phases, don't press Σ , just press SELECT for skip direct, and got the total power of 2 phases .
SAVE	<ul style="list-style-type: none"> ● Press once to store single reading, MEM appears and the Meter beeps. ● The maximum number of data store is 99, when it achieves 99, the Meter shows FUL. Press CLEAR to clear the stored reading in order to store next reading.
SELECT	<ul style="list-style-type: none"> ● At active power (main display) + phase angle (secondary display) mode, press SELECT button to step through first phase, second phase, third phase and sum of watts. ● At other mode, press SELECT to step through first phase, second phase and the third phase.
MIN / ▼	<ul style="list-style-type: none"> ● Press to start recording of minimum value, it valid at voltage, current, active power and apparent power ranges only. ● Press once at LOAD mode, MR icon shown, the Meter displays the previous stored reading, the left secondary display showing the index decrease one. ● Press once at mode, CAL icon shown, the Meter steps through sum of active power (main display) + sum of reactive power (secondary display) and sum of power factor (main display) + sum of apparent power.
CLEAR	<ul style="list-style-type: none"> ● At active energy range, press to reset time the zero, then restart the timing. ● At all other ranges, press to clear stored readings.

Display Symbols (see figure 3)

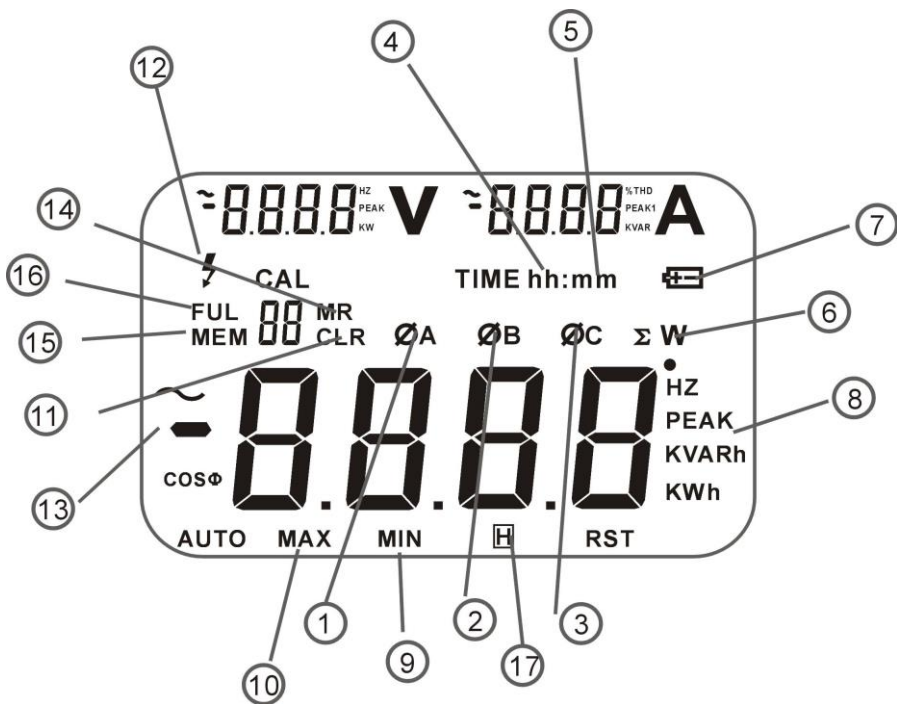







figure 3

Number	Symbol	Meaning
1	\emptyset A	First phase symbol
2	\emptyset B	Second phase symbol
3	\emptyset C	Third phase symbol
4	hh	Unit for hour
5	mm	Unit for minute
6	Σ W	Watt: Sum of Watt
7		The battery is low. ⚠ Warning: To avoid false readings, which could lead to possible electric shock or personal injury, replace the battery as soon as the battery indicator appears.
8		Symbol of Unit.
9	MIN	Minimum reading
10	MAX	Maximum reading
11	CLR	Indicator for clear the stored reading
12		High voltage symbol
13		Indicates negative reading
14	MR	Indicator for recall the stored reading
15	MEM	Indicator for data store
16	FUL	Indicator for data stored is full
17		Data hold is active

Measurement Operation

Preparation

- Turn on Rotary Switch .
- Replace the battery as soon as the battery indicator “” appears on the display.

A. AC Voltage (main display) + Frequency (secondary display) Measurement (see figure 4)

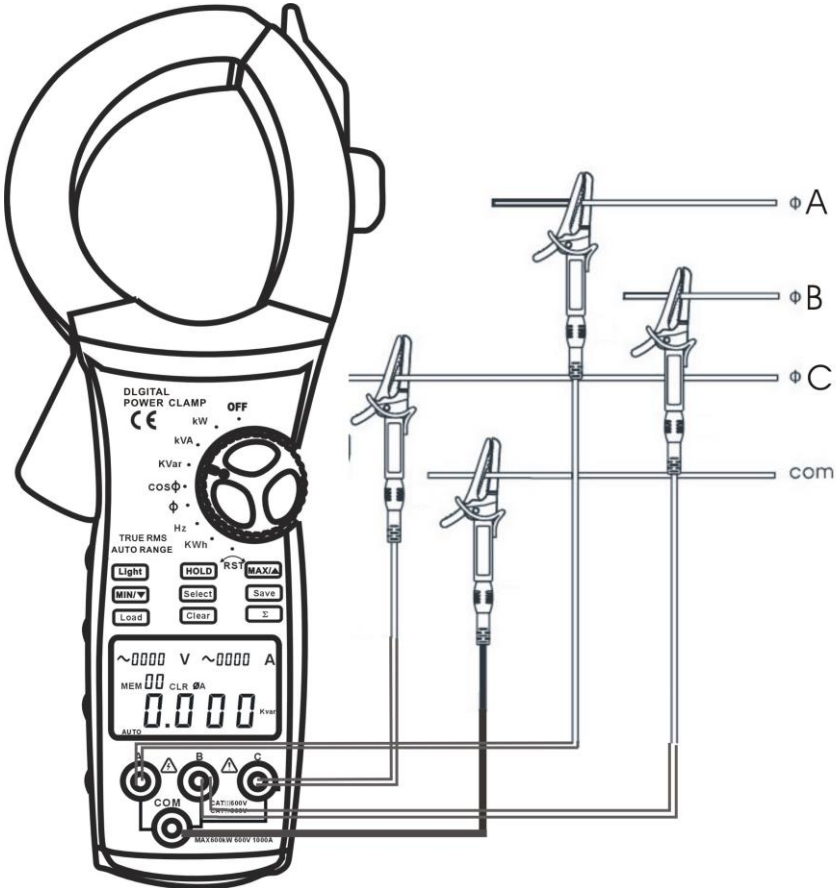

figure 4

The AC Voltage ranges are:15V, 100V, 300V and 600V

The frequency range is:20Hz~100Hz

To measure AC voltage + frequency, connect the Meter as follows:

1. Insert the red test lead into the **V A** terminal, blue test lead into the **V B** terminal, yellow test lead to **V C** input terminal and black test lead to the **COM** input terminal.
2. Connect the red test leads (**VA** input terminal), blue test leads (**VB** input terminal) and yellow test leads (**VC** input terminal) to the corresponding three phases loaded live wire. Black test lead (COM input terminal) to the corresponding three phases loaded neutral wire.
3. Press **SELECT** to select phase location, the display shows the corresponding phase symbol. **VA** means the first phase \emptyset **A**, **VB** means the first phase \emptyset **B**, **VC** means the first phase \emptyset **C**.
4. The display shows the corresponding True RMS voltage value and frequency value of each phase.
5. Press **MAX/▲** , the LCD displays MAX, it starts recording the maximum AC voltage True RMS value. Press **MAX/▲** again to show the current AC voltage True RMS value.
6. Press **MIN/▼** the LCD displays MAX, it starts recording the minimum AC voltage True RMS value. Press **MAX/▼** again to show the current AC voltage True RMS value.
7. The display shows **9999** when the input voltage is higher than 600V rms.

Note

●When the measurement has been completed, disconnect the connection between the testing leads and the circuit under test and remove testing leads from the input terminals.

B. AC Current (main display) + AC Voltage (secondary display) Measurement

The AC current ranges are: 40A, 100A, 400A and 1000A

The AC Voltage ranges are: 15V, 100V, 300V and 600V

To measure AC current + AC voltage, connect the Meter as follows:

1. Press the **Kw** to select AC Current (main display) + AC Voltage (secondary display) range.
2. Press the lever to open the transformer jaw.
3. Center the conductor within the transformer jaw, then release the Meter slowly until the transformer jaw is completely closed, Make sure the conductor to be tested is placed at the center of the transformer jaw,

otherwise it will cause deviation. The Meter can only measure one conductor at a time, to measure more than one conductor at a time will cause deviation.

4. The double display shows the AC current True RMS value and AC voltage True RMS value.

5. Press **MAX/▲**, the LCD displays MAX, it starts recording the maximum AC current True RMS value.

Press **MAX/▲** again to show the present AC True RMS value.

6. Press **MIN/▼**, the LCD displays MAX, it starts recording the minimum AC current True RMS value. Press **MAX/▲**, again to show the present AC current True RMS value.

7. The display shows **9999** when the current of the tested conductor is higher than 1000A rms.

Note

● When the measurement has been completed, disconnect the connection between the conductor under test and the jaw, and remove the conductor away from the transformer jaw of the Meter.

C. Active Power (main display) + Phase Angle (secondary display) Measurement

The active power ranges are: 40A, 100A, 400A and 1000A

The phase angle ranges are: 0° ~360°

⚠ Warning

To avoid damages to the Meter or harms to you, do you measure higher than AC voltage 600 v.r.s. and AC current 1000A v.r.s.

To measure active power + phase angle, connect the Meter as follows:

1. Press the **MENU** to select Active power (main display) + Phase angle (secondary display) range.

2. Press the lever to open the transformer jaw, and clamp them to the corresponding phase of tested conductor. If user needs to measure any phase of the 3 phase, then clamp them to that phase's conductor.

3. Connecting method (see figure 6, 7, 8):

● When measuring 3 phase 4 wires, connect the Meter as figure 6.

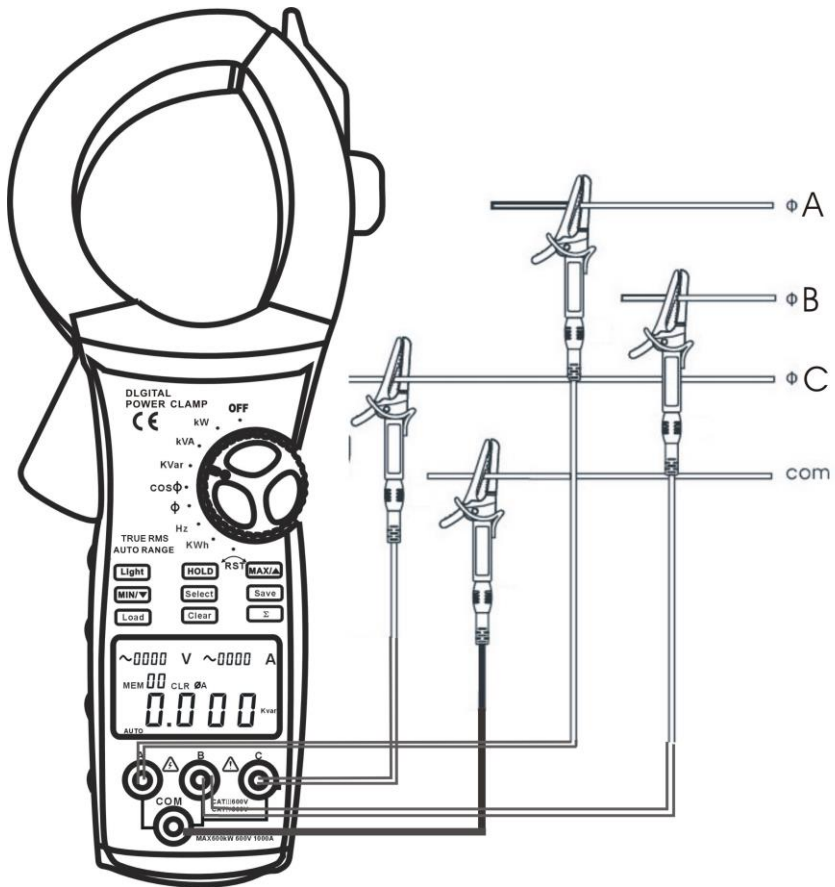

figure 6

- Insert red test leads to **A** input terminal.
- Insert blue test leads to **B** input terminal
- Insert yellow test leads to **C** input terminal and connecting it to every live wire of the 3 phase.
- Insert black test leads to **COM** input terminal and connect it to the neutral wire of the 3 phase.

- When measuring 3 phase 3 wires, connect the Meter as figure 7.

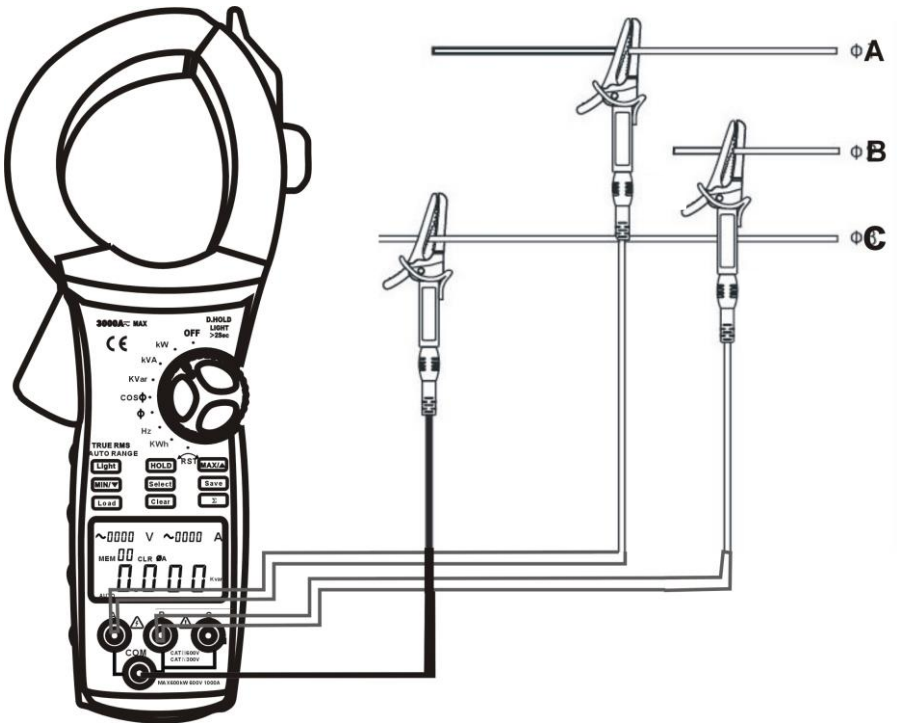

figure 7

- Insert red test leads to **A** input terminal.
- Insert blue test leads to **B** input terminal
- Insert black test leads to **COM** input terminal and connect it to the neutral wire of the 3 phase.

- When measuring single phase 2 wires, connect the Meter as figure 8

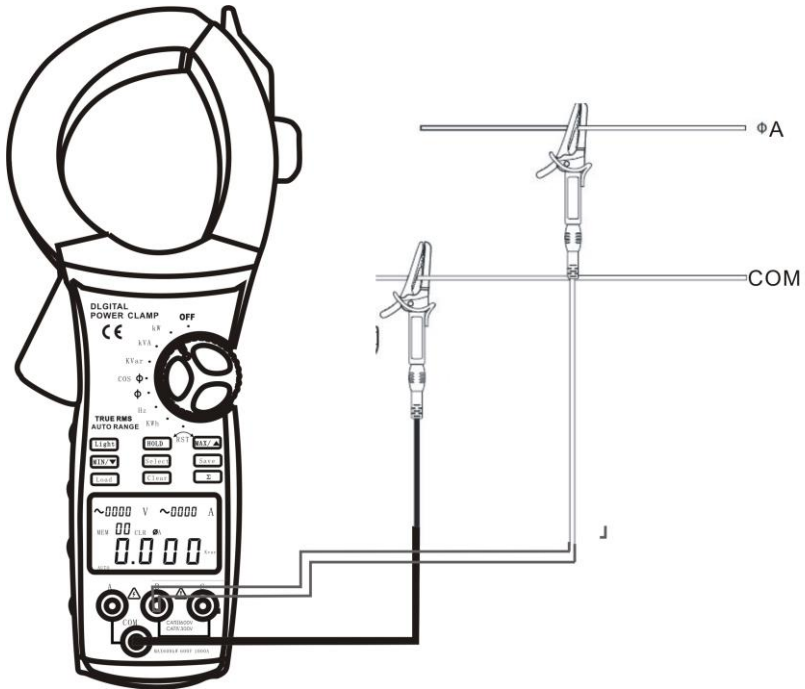

figure 8

➤ Insert red test lead to **A**, **B** or **C** input terminal corresponding to one of **Φ A**, **Φ B** or **Φ C** phase

➤ Insert black test leads to **COM** input terminal.

➤ Connecting the two test leads to live and neutral wires.

4. When measuring 3 phases 4 wires:(see figure 9, 10, 11, 12, 13, 14, 15, 16)

● Press **SELECT** to choose first phase **Φ A**, see figure 9. The double displays show the active power kW value and also the voltage and current value of **Φ A**.



figure 9

- If necessary, press Σ to get the sum of watts as figure 10.



figure 10

- After sum up the current power measurement value of the first phase, then press **SELECT** to choose the second phase Ø B, as figure 11



figure 11

- The double display shows the value of active power kW and voltage current of Ø B.

- If necessary, press Σ to get the sum of watts as figure 12.

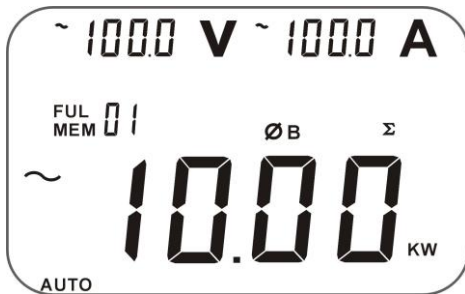

figure12

- After sum up the current power measurement value of the second phase, then press **SELECT** again to choose the third phase Ø C, as figure 13.

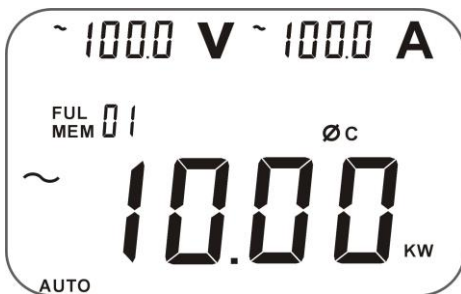

figure 13

- The double display shows the value of active power KW and voltage current of Ø C.
- If necessary, press Σ to get the sum of watts as figure 14

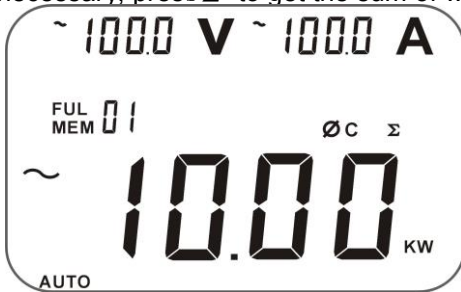

Figure14

- After sum up the current power measurement value of the third phase,

finally press **SELECT** again to display the 3 phase sum of active power value and reactive power value.

- Press **MAX/▲** or **MIN/▼** as figure 15 to step through in sequence three phase sum of active power+ three phase sum of reactive power, and three phase sum of power factor + 3 phase sum of apparent power.



Figure15

5. When measuring 3 phase 3 wires:

- The first and second phase measuring method is same as 3 phase 4 wires.
- Jump over the third phase measurement.
- Press **SELECT** to display the 3 phase sum of active power and reactive power.
- Press **MAX/▲** or **MIN/▼** as figure 16 to step through in sequence three phase sum of active power+ three phase sum of reactive power, and three phase sum of power factor + 3 phase sum of apparent power.



Figure16

6. The maximum power is 600kW of single phase, **9999** will be displayed

when it is over than that. The maximum range is 1800kW of three phase sum of active power, **9999** will be displayed when it is over than that.

7. Press **MAX/▲** , the display shows MAX, it starts recording the maximum active power value. Press again to display the current active power value.

8. Press **MIN/▼** , the display shows MIN, it starts recording the minimum active power value. Press again to display the current active power value.

Note

- When there is no input or single phase, the Meter displays 9999. Σ button is not valid.
- It can only sum up the current measurement value. The maximum and minimum value cannot be summed up.
- Only at this range can carry out sum of watts measurement, other ranges cannot carry out this measurement.
- When testing has been completed, disconnect the connection between the testing leads and the circuit under test and remove testing leads from the input terminals.

D. Apparent Power (main display) + Reactive Power (secondary display) Measurement.

To avoid damages to the Meter or harms to you, do you measure higher than AC voltage 600V rms and AC current 1000A rms.

Warning

1. To test for Apparent power (main display) + Reactive power (secondary display), connect the Meter as follows: Press the **MENU** to select Apparent power (main display) + Reactive power (secondary display) range.
2. Press the lever to open the transformer jaw, and clamp them to the corresponding phase of tested conductor. If user needs to measure any phase of the 3 phase, then clamp them to that phase's conductor.
3. The connecting method of 3 phases 4 wires, 3 phases 3 wires or single phase 2 wires, see figure 6, 7 and 8
4. When measuring 3 phase 4 wires:(see figure 17, 18, 19)
 - Press **SELECT** to choose the first phase **A**, see figure 17.

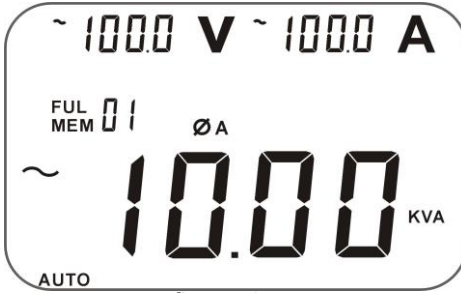

figure 17

- The double display shows the first phase value of apparent power kVA and reactive power Kvar. Then press **SELECT** again to choose the second
- phase **B**, see figure 18.

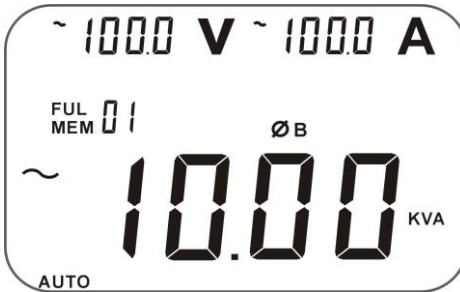

figure 18

- The double display shows the second phase value of apparent power kVA and reactive power Kvar.
- Press **SELECT** again to choose the third phase **3**, see figure 19.



figure 19

- The double display shows the third phase value of apparent power kVA and reactive power Kvar.

5. When measuring 3 phase 3 wires:

- The first phase and second phase operating method is same as three phase 4 wires.
- Jump over the third phase measurement.

6. The maximum measuring range is 600kW when measuring single phase apparent power kVA and reactive power Kvar, **9999** will be displayed when it is over than that.

7. Press **MAX/▲**, the display shows MAX, it starts recording the maximum apparent power value. Press again to display the current apparent power value.

8. Press **MIN/▼**, the display shows MIN, it starts recording the minimum apparent power value. Press again to display the current apparent power value.

Note

- When testing has been completed, disconnect the connection between the testing leads and the circuit under test and remove testing leads from the input terminals.

E. Power Factor (main display) + Phase Angle (secondary display) Measurement Warning to avoid damages to the Meter or harms to you, do you measure higher than AC voltage 600V rms and AC current 1000A rms.

To test for Power factor (main display) + Phase angle (secondary display), connect the Meter as follows:

1. Press the **MENU** to select Power factor (main display) + Phase angle (secondary display) range.
2. Press the lever to open the transformer jaw, and clamp them to the corresponding phase of tested conductor. If user needs to measure any phase of the 3 phase, then clamp them to that phase's conductor.
3. The connecting method of 3 phases 4 wires, 3 phases 3 wires or single phase 2 wires, see figure 6, 7 and 8
4. When measuring 3 phase 4 wires: (see figure 20, 21, 22)
 - Press **SELECT** to choose the first phase **A**, see figure 20.



figure 20

- The double display shows the first phase value of power factor PF and phase angle PG.
- Then press **SELECT** again to choose the second phase **B**, see figure 21.



figure 21

- The double display shows the second phase value of power factor PF and phase angle PG.
- Press **SELECT** again to choose the third phase **3**, see figure 22.



figure 22

- The double display shows the third phase value of power factor PF and phase angle PG.

5. When measuring 3 phase 3 wires:

- The first phase and second phase operating method is same as three phase 4 wires.

- Jump over the third phase measurement.

6. MAX/ ▲ and MIN/ ▼ are not valid when measuring power factor.

Note

- When testing has been completed, disconnect the connection between the testing leads and the circuit under test and remove testing leads from the input terminals.

F. Active Energy (main display) + Time (secondary display) Measurement

Warning

To avoid damages to the Meter or harms to you, do you measure higher than AC voltage 600V rms and AC current 1000A rms.

To test for Active Energy (main display) + Time (secondary display), connect the Meter as follows:

1. Press the **MENU** to select Power factor (main display) + Phase angle (secondary display) range.
2. Press the lever to open the transformer jaw, and clamp them to the corresponding phase of tested conductor. If user needs to measure any phase of the 3 phase, then clamp them to that phase's conductor
3. The connecting method of 3 phase 4 wires, 3 phases 3 wires or single phase 2 wires, see figure 6, 7 and 8
4. Press **SELECT** to choose one of the three phases (**1, 2, 3**), see figure 23.

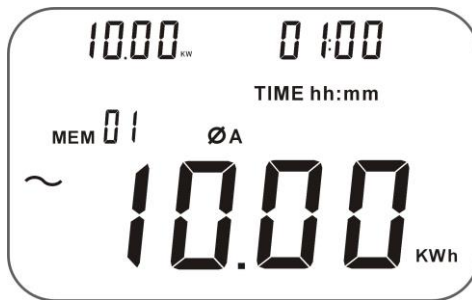

figure 23

- The double display shows the value of tested object's active energy

kWh value and the measuring time of the corresponding phase.

- The measuring reading gets increasing along with the time increases. Press **HOLD** to read a particular time kWh value. Then the reading and time are locked, but still continuous accumulate measuring time.

- After read the data, press **HOLD** again to continuous measurement. kWh value continuous accumulate and the measuring time jumps to the present measuring time.

- When the measuring time is over 24 hours or the Meter is switched to other measuring ranges, active energy measuring will stop.

- The maximum reading of active energy is 9999kWh. **9999** will be displayed when the reading is over than that.

5. **MAX/▲** and **MIN/▼** are not valid when measuring active energy.

6. Press **CLEAR** to reset the time.

Note

- When there is no input signal, it cannot carry out active energy measurement.

- When there is input signal, the maximum waiting time is around 10s before timing.

- When testing has been completed, disconnect the connection between the testing leads and the circuit under test and remove testing leads from the input terminals.

G. Phase Angle(ϕ)+Voltage(V)+Current(A)

(1) Turn on Rotary Switch to " ϕ " function.

(2) Press the lever to open the transformer jaw, and clamp them to the corresponding phase of tested conductor. If user needs to measure any phase of the 3 phase, then clamp them to that phase's conductor.

(3) The connecting method of 3 phases 4 wires, 3 phases 3 wires or single phase 2 wires, see figure 4, 5 and 6

(4) Press SELECT to choose the phase ϕ A. See figure 24



figure 24

The double display shows the ϕA value of phase Angle ϕ , Voltage value and also Current value. Then press SELECT to choose Second phase ϕB

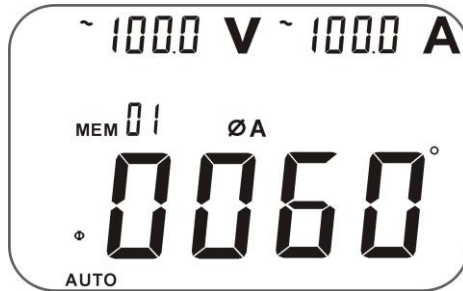

figure 25

The double display shows the ϕB value of phase Angle ϕ , Voltage value and also Current value. Then press SELECT to choose Second phase ϕC



figure 26

Measuring 1 phase and 2 phase as same as 3 phase 4 wires. Skip the third phase measurement

(5) This feature file, no maximum and minimum measurement

Warning

To avoid damages to the meter or harms to you, do you measure higher than AC voltage 600(r.m.s) and AC Current 1000A (r.m.s)

H. Frequency(Hz)+Voltage(V)+Current(A)

(1) Set the Rotary Switch to " Hz " position.

(2) Press the lever to open the transformer jaw, and clamp them to the corresponding phase of tested conductor. If user needs to measure any phase of the 3 phase, then clamp them to that phase's conductor.

(3)The connecting method of 3 phases 4 wires, 3 phases 3 wires or single phase 2 wires, see figure 4, 5 and 6

(4) Press SELECT to choose the first phase ϕA . See figure 27.

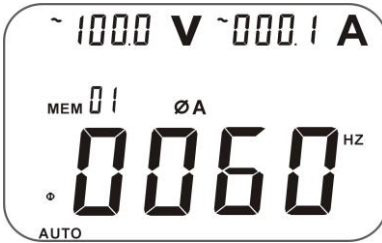

figure 27

The double display shows the ϕA value of Frequency Hz Voltage value and also Current value. Then press SELECT to choose 2 phase ϕB See figure 28



figure 28

The double display shows the ϕB value of Frequency Hz Voltage value and also Current value. Then press SELECT to choose 3 phase ϕB See figure 29



figure29

The double display shows the ϕB value of Frequency Hz Voltage value and also Current value. When measuring 3 phase 3 wires:

The first phase and second phase operating method is same as third phase

4 wires. Jump over the third phase measurement

(5) This feature file, no maximum and minimum measurement

Warning

To avoid damages to the meter or harms to you, do you measure higher than AC voltage 600(r.m.s)and AC Current 1000A (r.m.s)

Frequency measurement is the voltage signal measured the frequency, not the current signal of frequency.

I Active Energy(kWh)+Active Power(kW)+Time(mm:s)

(1) Set the Rotary Switch to " kWh " position.

(2) Clamp the corresponding target test lead (Clamp A test lead for measure A phase....)

(3) The connecting method of 3 phases 4 wires, 3 phases 3 wires or single phase 2 wires, see figure 4, 5 and 6

(4) Press **SELECT** to choose one of  **A**,  **B** or  **C** phase (as figure 30)

- The double display shows tested object's active energy kWh value and the measuring time of the corresponding phase.

- The measuring reading gets increasing along with the time increases.

Press **HOLD** to read a particular time kWh value. Then the reading and time are locked, but still continuous accumulate measuring time.

- After read the data, press **HOLD** again to continuous measurement. kWh value continuous accumulate.

- When the measuring time is over 24 hours or the Meter is switched to other measuring ranges, active energy measuring will stop.

- The maximum reading of active energy is 9999kWh. **9999** will be displayed when the reading is over than that.

(5) This feature file, no maximum and minimum measurement

(6) Press **CLEAR** to reset the time

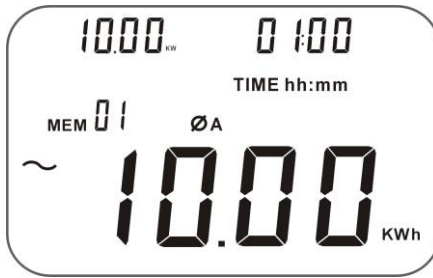

figure30

⚠ Warning

- 1) To avoid damages to the meter or harms to you,do you measure higher than AC voltage 600(r.m.s)and AC Current 1000A (r.m.s)
- 2) No signal excluding the measurement of power, signal input, needs to wait for a maximum time of 10 S start time.
- 3) The data is not saved after power off, After reboot re-count

J Phase sequence detection

(1) Turn on Rotary Switch to select “RST ”, (figure 30)

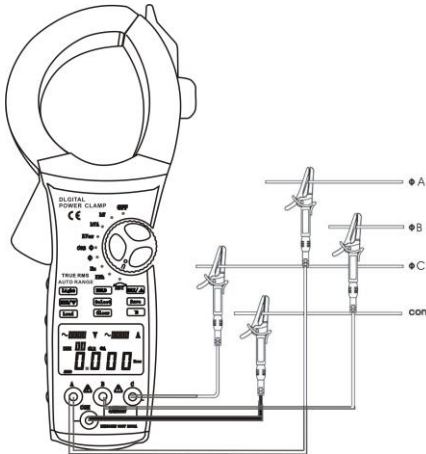

figure 30

Put Red test lead into “ V A” hole, put blue test lead into “ V B ”,Put Yellow test lead into “VC” hole, Put black test lead into “COM” hole. And put the four test pens connected to the await measuring power supply or load side

of three-phase and ground terminal. For the three-phase four-wire loading return circuit, Meter displays the phase sequence test results.

(2) Three horizontal line from top to bottom on behalf of A, B, C phase, Such as lack of one phase, will be displayed. Lack A Phase will missing the top of the horizontal line. Lack B phase will missing the bottom of the horizontal line. As shown in Figure 25, on behalf of lack of A phase voltage.

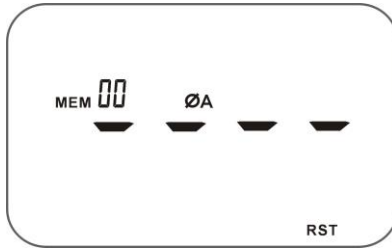

figure 25

(3) If the three-phase positive sequence, it will show "E", as shown in Figure 26.



Figure 26

(4) If the three-phase anti-order, it will display "Y", as shown in Figure 27,



Figure 27

Positive sequence arrange is shown below, “A” hole , “B” hole and “C” hole are connect A phase, B phase, C phase according to below form, and when the three phase voltage is beyond 100v , LCD display Positive sequence test results. In Figure 35



positive sequence

	hole		
	a	b	c
A、 B、 C phasic	A	B	C
	B	C	A
	C	A	B
test results	Positive sequence		

(5) Three-phase four-wire loads, if it has no signal or a phase voltage less than 100V, when, LCD display missing-phase test results.

Note: The positive and negative sequence detection voltage range of 100V ~ 500V.

True RMS Measurement and Average Value Measurement

The True RMS measurement method can measure accurately the effective value of non-sine wave input signal.

Average value measurement method can measure the mean value of one sine wave input signal, and then displays it as RMS value

When the input waveform has distortion, measuring tolerance will be included. The total tolerance depends on the total distortion. Below table 1 shows the waveform coefficient and the relationship and the requested changing factor of sine wave, square wave, pulse rectangle wave, sawtooth triangle wave, RMS value and average value.

Specifications

A. General Specifications

- Maximum Voltage between any Terminals and grounding: Refer to different range input protection voltage.

- Display: Multi LCD displays, Maximum display 9999.
- Ranges: Auto
- Overloading: Display **9999**.
- Battery Deficiency: Display .
- Data Holding: Display
- Data Logging: Maximum 99, Single or Continuous records
- Data Recall
- Maximum and Minimum value display: Voltage, Current, Active Power and Apparent Power ranges
- Display Backlight: White color
- Calibration Feature
- Sleep Mode: To preserve battery life, the Meter automatically turns off if you do not turn press any button for around 15 minutes., except at active factor range.
- Sampling: 3 times per second.
- Max. Jaw Size: 55mm diameter.
- Analogue Bar Graph
- Power: **9 V Alkaline batteries**
- Dimensions: 303mm x 112mm x 39mm
- Weight: Approximate 601g

B. Environmental Requirements

- The Meter is suitable for indoor use.
- Altitude: Operating: 2000m

Storage: 10000m

- Temperature and humidity:

Operating:

0 ~ 30 (85%R.H)

30 ~ 40 (75%R.H)

40 ~ 50 (45%R.H)

Storage:-10 ~ +60 (85%R.H)

- Safety/ Compliances: IEC 61010 CAT.III 600V, CAT.IV 300V overvoltage and double insulation standard, pollution degree 2

● Certification:

Accurate Specifications

Accuracy :±(a% reading + b digits),guarantee for 1 year.

Operating temperature:23°C±5°C

Operating humidity:45~75%R.H

A. AC Voltage (True RMS)

Range	Resolution	Accuracy	Allowable Maximum overload protection voltage	Input Impedance
15V	0.1V	± (1.2%+5)	600 RMS	10 MΩ
100V				
300V				
600V				

B. Frequency

Range	Resolution	Accuracy
20Hz~100Hz	1Hz	± (0.5%+5)

Min Input Voltage: 10V

C. AC Current (True RMS)

Range		Resolution	Accuracy	Allowable Maximum overload protection current
40A		0.1A	± (2.5%+15)	1000A RMS
400A				
1000A	400-800	1A	± (2.5%+15)	
	800-1000		± (3.5%+20)	

·Allowable maximum overload protection current:1000A RMS

C. Active Power (w=V×A×COS Φ)

D.

Current/Voltage		Voltages Range			
		15V	100V	300V	600V
Current Range	40A	0.60kW	4.00kW	12.00kW	24.00kW
	100A	1.50kW	10.00kW	30.00kW	60.00kW
	400A	6.00kW	40.00kW	120.0kW	240.0kW
	1000A	15.00kW	100.0kW	300.0kW	600.0kW
Accuracy		± (3%+15)			
Resolution		$< 1000\text{KW}:0.01\text{KW}$ $\geq 100\text{KW}:0.1\text{KW}$			

Remarks

Min Input Voltage: 10V

- Allowable maximum overload protection voltage: 600V RMS
- Allowable maximum overload protection current: 1000A RMS

E. Apparent Power (VA = V × A)

Current/Voltage		Voltages Range			
		15V	100V	300V	600V
Current Range	40A	0.60kVA	4.00kVA	12.00kVA	24.00kVA
	100A	1.50kVA	10.00kVA	30.00kVA	60.00kVA
	400A	6.00kVA	40.00kVA	120.0kVA	240.0kVA
	1000A	15.00kVA	100.0kVA	300.0kVA	600.0kVA
Accuracy		± (3%+15)			
Resolution		$< 1000\text{KVA} :0.01\text{KVA}$ $\geq 100\text{KVA} :0.1\text{KVA}$			

Remarks:

.Min Input Voltage: 10V

- Allowable maximum overload protection voltage: 600V RMS

·Allowable maximum overload protection current:1000A RMS

F. Reactive Power (Var =V×A×SINΦ)

Current/Voltage		Voltages Range			
		15V	100V	300V	600V
Current Range	40A	0.60kVar	4.00kVar	12.00kVar	24.00kVar
	100A	1.50kVar	10.00kVar	30.00kVar	60.00kVar
	400A	6.00kVar	40.00kVar	120.0kVar	240.0kVar
	1000A	15.00kVar	100.0kVar	300.0kVar	600.0kVar
Accuracy		15V/1000A Range :±(4%+25) Other Range :±(4%+20)			
Resolution		< 1000kVar:0.01kVar ≥ 100kVar:0.1kVar			

Remarks

Min Input Current/Voltage: 10A/10V

·Allowable maximum overload protection voltage:600V RMS

·Allowable maximum overload protection current:1000A RMS

G. Power Factor (PF = W/VA)

Range	Accuracy	Resolution	Measuring Condition
0.3~1 (capacitive or inductive)	±0.022	0.001	The minimum measuring current 10A The minimum measuring voltage 45V
0.3~1 (capacitive or inductive)	For reference only		Measuring current less than 10A OR Measuring voltage less than 45V

Remarks

·Min Input Voltage: 10V

·Allowable maximum overload protection voltage:600V RMS

·Allowable maximum overload protection current:1000A RMS

H. Phase Angle ($PG = \cos(PF)$)

Range	Accuracy	Resolution	Measuring Condition
0°~360°	±1°	1°	The minimum measuring current 10A The minimum measuring voltage 45V
0°~360°	For reference only		Measuring current less than 10A OR Measuring voltage less than 45V

·Min Input Current/Voltage: 10A/10V

I. Active Energy (kWh)

Range	Accuracy	Resolution
1~9999kWh	±(3%+2)	0.001kWh

Remarks:

- Allowable maximum overload protection voltage:600V RMS
- Allowable maximum overload protection current:1000A RMS

MAINTENANCE

This section provides basic maintenance information including battery replacement instruction.

Warning

Do not attempt to repair or service your Meter unless you are qualified to do so and have the relevant calibration, performance test, and service information.

To avoid electrical shock or damage to the Met do not get water inside the case.

A. General Service

- Periodically wipe the case with a damp cloth and mild detergent. Do not use abrasives or solvents.
- To clean the terminals with cotton bar with detergent, as dirt or moisture in the terminals can affect readings.
- Turn the Meter power off when it is not in use.

- Take out the battery when it is not using for a long time.
- Do not use or store the Meter in a place of humidity, high temperature, explosive, inflammable and strong magnetic field.

B. Replacing the Battery

Warning

To avoid false readings, which could lead to possible electric shock or personal injury, replace the battery as soon as the battery indicator “*b*” appears.

Make sure the transformer jaw and the tests leads are disconnected from the circuit being tested before opening the case bottom.

To replace the battery:.

1. Press **POWER** to turn the Meter off and remove all the connections from the input terminals
2. Turn the Meter's front case down.
3. Remove the screw from the battery door, and separate the battery door from the case bottom.
4. Rejoin the case bottom and the battery compartment ,and reinstall the screw.



1141 Budapest, Fogarasi út 77. 1095 Budapest, Mester utca 34.
Tel.: *220-7940, 220-7814, 220-7959, Tel.: *218-5542, 215-9771, 215-7550,
220-8881, 364-3428 Fax: 220-7940 216-7017, 216-7018 Fax: 218-5542
Mobil: 30 531-5454, 30 939-9989 Mobil: 30 940-1970, 20 949-2688

E-mail: delton@delton.hu Web: www.delton.hu

www.holdpeak.hu